



METHOD STATEMENT

Crack Injection with Sika[®] Injection-201 CE

19.07.2019 / VERSION 01 / SIKA LIMITED (VIETNAM) / NGUYEN CONG HUNG

TABLE OF CONTENTS

1	Scope	3
2	Description	3
2.1	Limitations	3
3	References	3
4	Products	3
4.1	Material Storage	3
5	Equipment	4
5.1	Injection equipment	4
6	Health and safety	5
6.1	Personal protection	5
6.2	First aid	6
7	Environment	6
7.1	Cleaning Tools / Equipment	6
7.2	Waste disposal	6
8	Substrate preparation	6
9	Installation of drill-hole/mechanical Packer	7
10	Mixing	8
11	Injection	8
11.1	Waterproofing and flexible repairs of dry & wet cracks and cracks without hydrostatic pressure	9
11.2	Injection of wet cracks with hydrostatic pressure	10
11.3	Application Limits	12
12	Disclaimer	13

Method Statement

Crack Injection with Sika® Injection-201 CE
19/07/2019, Version 01

1 SCOPE

This method statement describes the step by step procedure for waterproofing of cracks through injection.

2 DESCRIPTION

This method statement describes the flexible sealing of wet cracks, with and without hydrostatic water pressure in reinforced concrete with polyurethane resins.

2.1 LIMITATIONS



- Products shall only be applied in accordance with their intended use.
- Local product differences may result in performance variations. The most recent and relevant local Product Data Sheets (PDS) and Material Safety Data Sheets (MSDS) shall apply.
- All work shall be carried out as directed by a supervising officer or a qualified specialist.
- This method statement is only a guide and shall be adapted to suit local products, standards, legislation or other local requirements.

3 REFERENCES

To ensure correct application of all components of *Sika® Injection*, please refer to the following documents of each product component:

- PDS (Product Data Sheet)
- MSDS (Material and Safety Data Sheet)

4 PRODUCTS

Sika Products Injection Material		Description Key words
Sika® Injection-201 CE		PU-base, non-foaming, flexible injection resins with low viscosity for durable waterstop, flexible.
Sika® Injection-101 RC		PU-base, foaming injection resins for temporary waterstop only.

4.1 MATERIAL STORAGE

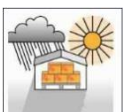

Materials shall be stored properly in undamaged original sealed packaging, in cool, dry conditions. Refer to specific information contained in the product data sheet regarding minimum and maximum storage temperatures.

5 EQUIPMENT

5.1 INJECTION EQUIPMENT

1-Component Injection pump
equipped with a hose and ball valve

A piston pump is recommended



Nipple-gripper for round-head nipples.
Connection between the pump and the
injection packer



Mechanical Packer



Driller:
Diameter: >9mm depending on packer
Length : >250mm depending on structure



Impact drill



Tool box with screwdrivers, wrenches, ratchet set (Diameter
>6mm up to 24mm), tongs, etc.



Battery drill



Plenty of clean buckets



Measured bucket



Cleaning towels



6 HEALTH AND SAFETY

6.1 PERSONAL PROTECTION

Work Safely!



Handling or processing injection products can cause chemical irritation to the eyes, skin, nose and throat.

Appropriate eye protection should be worn at all times while handling and mixing products.

Safety shoes, gloves and other appropriate skin protection must be worn at all times.

Always wash hands with suitable soap after handling products and before food consumption.

In addition to protective clothing it is also recommended to use a barrier cream on the skin. If any injection resin gets on clothing, remove the garment at once. The friction of resin-saturated fabric on the skin can cause serious chemical burns. Wash your exposed skin occasionally during the workday and immediately if any material gets on

it. Avoid using solvents, since they can help material penetrate into the skin and solvents themselves are aggressive and harmful to the skin. Avoiding skin contact by keeping tools and equipment clean is one of the best ways to protect oneself. Despite safety precautions, with any instances of skin contact rinse immediately with clean warm water and use soap to thoroughly clean the skin.

FOR DETAILED INFORMATION REFER TO THE MATERIAL SAFETY DATA SHEET

6.2 FIRST AID



Seek immediate medical attention in the event of excessive inhalation, ingestion or eye contact causing irritation. Do not induce vomiting unless directed by medical personnel.

Flush eyes with plenty of clean water, occasionally lifting upper and lower eyelids. Remove contact lenses immediately. Continue to rinse eye for 10 minutes and then seek medical attention.

Rinse contaminated skin with plenty of water. Remove contaminated clothing and continue to rinse for 10 minutes and seek medical attention.

FOR DETAILED INFORMATION REFER TO THE MATERIAL SAFETY DATA SHEET OF THE CORRESPONDING PRODUCT!

7 ENVIRONMENT

7.1 CLEANING TOOLS / EQUIPMENT

Tools and equipment used for mixing and applying *Sika® Injections* can be cleaned according to the PDS *Sika® Injection Cleaning Systems*.

7.2 WASTE DISPOSAL



Do not empty surplus material into drains. Dispose responsibly through a licensed waste disposal contractor in accordance with legislation and local / regional authority requirements. Avoid run-off into soil or waterways, drains or sewers.

Hardened resins can be disposed of with other combustible waste in a waste incineration plant. Under no circumstances burn the resin in an open fire, due to the potentially dangerous gases which could be released. Uncured resin must be disposed of as hazardous waste. It is forbidden to mix it with conventional waste.

FOR DETAILED INFORMATION REFER TO THE MATERIAL SAFETY DATA SHEET

8 SUBSTRATE PREPERATION

Cleaning of the surface helps the technician to identify the exact location and the width of the crack to be injected. Sometimes the concrete surface is hidden under a surface of mineral deposits left from long-term water leakage. Items that obscure the crack should be removed, because the crack must be seen clearly in order to lay out the drilling patterns for the injection holes.

The cracks must be free from loose particles, dust, oil, grease or any other contamination etc.

Method Statement

Crack Injection with Sika® Injection-201 CE
19/07/2019, Version 01

9 INSTALLATION OF DRILL-HOLE/MECHANICAL PACKER

In order to inject the resin into a dry or wet crack that reaches into the middle of the structure, it is necessary to install mechanical injection packers. The correct drilling method is very important in order to make a proper injection and to ensure a continuous injection result for durable crack sealing.

Drill packer holes at a 45° angle to the concrete

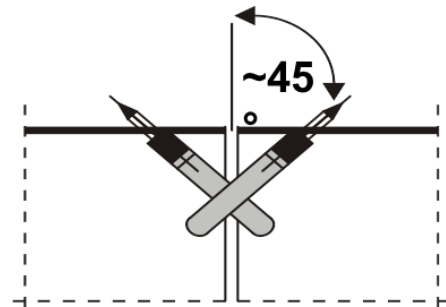

Dimension of the drill-hole depending on the used packer and thickness of the wall:

\varnothing of drill hole = \varnothing of packer + 1 mm

Drill hole depth:

$\sim d$ = long enough to reach minimum the middle of the structure under approx. 45° drilling angle



d: building component thickness

d/2: interval

- from packer to packer
- from packer to crack

The packer will be placed alternately on both sides of the crack.

After drilling please remove the dust e.g. using compressed air. Otherwise the dust can block the crack.

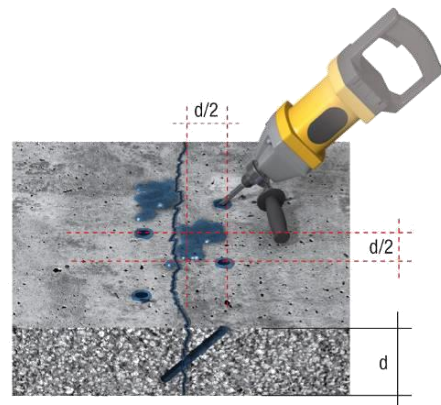

Place Sika® Injection Packers in the previously drilled hole, so that the top of the rubber sleeve is below the concrete surface. If the packer can't be pushed into the hole, tap it in.

Tighten the packer with a wrench. Remove the nipples in order to check the flow of water and injection resin later on.



Method Statement

Crack Injection with Sika® Injection-201 CE
19/07/2019, Version 01

Fix only the non-return valve (e.g. nipple) on the first (starting) packer.

In horizontal cracks the starting packer is the one at narrowest part of the crack.

In vertical cracks the starting packer is the lowest one.

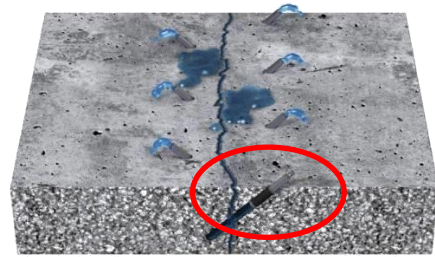

Drilling



Cleaning



Wrenching

10 MIXING

Prepare the injection material *Sika® Injection-201 CE* according to the PDS and pour it into the injection hopper connected to the pump. Stir briefly and use within the pot life. Always mix only the requirement amount.

11 INJECTION

The technician should be carefully watching three points of reference:

- The crack/packer Resin flowing out of the work face
- The pressure line For pump pulsations indicating resin flow.
- The gauge (if available) For actual injection pressure applied.

Begin the injection at the point of highest resistance to ensure good penetration and minimal loss of chemicals. This is usually the lowest point on a vertical crack and the narrowest area on a horizontal surface.

11.1 WATERPROOFING AND FLEXIBLE REPAIRS OF DRY & WET CRACKS AND CRACKS WITHOUT HYDROSTATIC PRESSURE

Products: Sika® Injection-201 CE

Start pumping

Once the connection is made, start the pump and begin injecting through the starting injection packer. The nipple is fixed on this packer.

Pumping method

Now the filling of the packer, packer hole and crack will start.

Injection can be successfully performed at the lowest possible injection pressures. The piston pump should be set to the lowest level. This gives the material time to flow into all gaps.

Slow, low-pressure injections are more effective than rapid, high-pressure injections. A successful injection will be indicated by the pump's refusal of injection resin (the piston will quit pumping) or by the sight of *Sika® Injection-201 CE* seeping out of the crack. When this happens, hold the pressure for approximately 1 more minutes.



Attention: High injection pressure can damage the structure and can occur an additional damage of the structure (a zip effect). For maximum injection pressure see section 11.3.

The injection progress can be checked by monitoring injection material or water coming out of the crack or the next packer.

Injection process

If material flows out through a packer, close it with the non-return valve (e.g. nipple). Start pumping on the second packer.

If the material flows out through the crack, close the second packer.
Start pumping on the second packer.

This method should be repeated until all packers are injected.

We recommend a second injection within the curing time for each packer to optimize the injection result.

Method Statement

Crack Injection with Sika® Injection-201 CE
19/07/2019, Version 01

Packer (re-injection)	To be able to re-inject through the same packer, inject fresh material through the affected packer before the end of the curing time.
Stop pumping	After the injection is finished, stop the pump (or close the ball valve on the pump assembly). Disconnect the pump hose from the injection packer.
Finish	The joint is tight after curing of the material.
Preparing the surface	After curing, you can start to remove the packers and fill the drill hole with suitable mortar/patching material. Clean the surface of the crack.
Cleaning	Clean the pump and tools according to the PDS of <i>Sika® Injection Cleaning System</i>

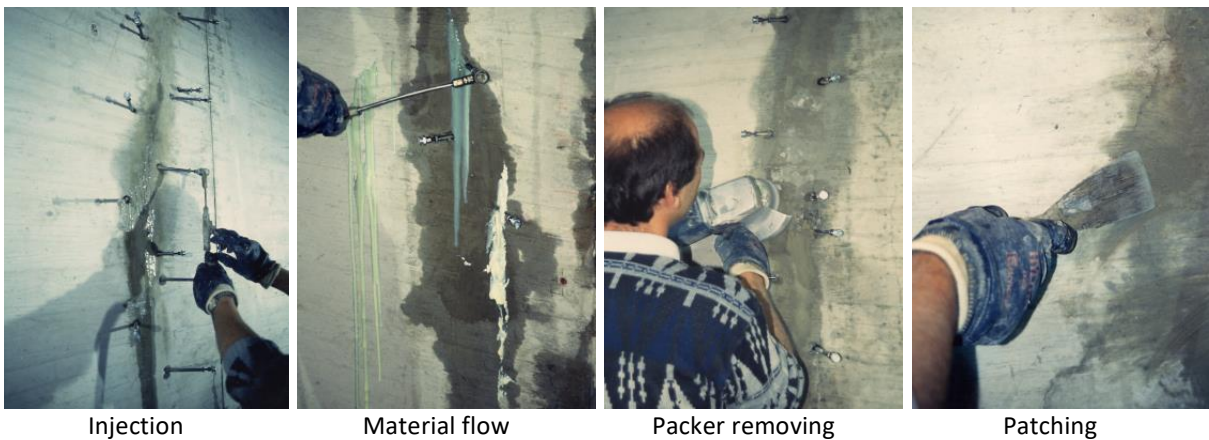

Injection

Material flow

Packer removing

Patching

11.2 INJECTION OF WET CRACKS WITH HYDROSTATIC PRESSURE

Products: Sika® Injection-101 RC for **temporary** waterstop.

Permanent flexible waterproofing through secondary injection of: Sika® Injection-201 CE

Start pumping	Once the connection is made, start the pump and begin injecting through the starting injection packer. The nipple is fixed on this packer. Please note: As soon as the Sika Injection-101 RC gets in contact with water it will start its reaction and foam after several seconds. There is enough time to inject the material through the packer into the crack.
----------------------	---

Pumping method	Now the filling of the packer, packer hole and crack will start.
-----------------------	--

Injection can be successfully performed at the lowest possible injection pressures. The piston pump should be set to the lowest level. This gives the material time to flow into all gaps.

Slow, low-pressure injections are more effective than rapid, high-pressure injections.

A successful injection will be indicated by the pump's refusal of injection resin (the piston will quit pumping) or by the sight of *Sika® Injection-101 RC* foaming and seeping out of the crack. When this happens, hold the pressure for approximately 2 more minutes.



Attention: High injection pressure can damage the structure and can occur an additional damage of the structure (a zip effect). For maximum injection pressure see section 10.3.

The injection progress can be checked by monitoring injection material or water coming out of the crack or the next packer.

Material information

The material in the injection packer will not cure or react as long as water can't flow into the packer. Special packers could be necessary where the valve is on the end of the packer instead of the nipple. Sika Injection-101 RC and all other polyurethane foams need contact with water to react. This means for the next approx. 6 hours (at approx. 25°C, depending on humidity) the permanent injection process with Sika Injection-201 CE resin as described above in section 11.1 can be started.

Please note:

Some packers could be blocked. In this case remove the blocked packer and drill back into the same hole with a driller, then place a new packer.

Injection process

If material flows out through a packer, close it with the non-return valve (e.g. nipple). Start pumping on the second packer.

If the material flows out through the crack, close the second packer. Start pumping on the second packer.

This method should be repeated until all packers are injected or the water stops flowing.

Secondary Injection process	A secondary injection with Sika Injection-201 CE is necessary to get the crack permanently watertight. This procedure is carried out to ensure the crack is completely filled and sealed with a non-foaming injection material. This requires the pressure a little bit higher to ensure that the Sika Injection-201 CE breaks the small bubbles in the foamed material of Sika Injection-101 RC and fills them.
Packer	To be able to re-inject through the same packer, always inject fresh material through the affected packer before the end of the curing time.
Stop pumping	After the injection is finished, stop the pump (or close the ball valve on the pump assembly). Disconnect the pump hose from the injection packer.
Finish	The joint is tight after curing of the Sika® Injection-201 CE.
Preparing the surface	After curing, the packers can be removed and fill the drill hole with suitable mortar/patching material. Clean the surface of the crack.
Cleaning	Clean the pump and tools according to the PDS of <i>Sika® Injection Cleaning System</i>

11.3 APPLICATION LIMITS

- Always check the material's pot life and adjust for climate conditions. Do a hand test before injection. Mix only the amount of material which you can flush out of the pump during materials gel-time, otherwise risk of blockage your pump.
- Sika® Injection-101 RC can only be used in combination with Sika® Injection-201 CE (or Sika® Injection-203, or Sika® Injection-307) to get permanent waterproofing.
- The maximum injection pressure can be calculated through:

$$P_{max} = (\text{Concrete Strength} \times 10) / 3$$

Where:

- Pmax is in bar
- Concrete Strength is in N/mm²

In general, don't try to reach this pressure. A good injection is an injection at low pressure for as long as possible in order to fill all the fine cracks / gaps.

12 DISCLAIMER

The information contained herein and any other advice are given in good faith based on Sika's current knowledge and experience of the products when properly stored, handled and applied under normal conditions in accordance with Sika's recommendations. The information only applies to the application(s) and product(s) expressly referred to herein and is based on laboratory tests which do not replace practical tests. In case of changes in the parameters of the application, such as changes in substrates etc., or in case of a different application, consult Sika's Technical Service prior to using Sika products. The information contained herein does not relieve the user of the products from testing them for the intended application and purpose. All orders are accepted subject to our current terms of sale and delivery. Users must always refer to the most recent issue of the local Product Data Sheet for the product concerned, copies of which will be supplied on request.

Sika Limited (Vietnam)

Nhon Trach 1 Industrial Zone
Nhon Trach, Dong Nai
Vietnam
vnm.sika.com

Phone: (+84-251) 3560 700
Fax: (+84-251) 3560 699
Mail: sikavietnam@vn.sika.com

Method Statement

Crack Injection with Sika® Injection-201 CE
19/07/2019, Version 01